

Застосування рідинних автобалансирів для компенсації експлуатаційних змін дисбалансу роторних систем без їх зупинки становить інтерес через відносну конструктивну простоту цих пристроїв, які є пасивними регуляторами прямої дії, що не потребують підведення енергії і системи керування для переміщення коригувальних мас. Відсутність досліджень впливу в'язкості рідини на ефективність автобалансування і обґрунтованості підбору рідини при конструюванні рідинних АБП поставило вимогу проаналізувати роботу рідинного АБП в реальній системі з врахуванням впливу властивостей рідини на ефективність процесу балансування вертикального ротора. Показано, що ефективність балансування зростає при наближенні кутової швидкості до критичної і при збільшенні зовнішнього опору; для рідинних АБП масові сили робочої рідини мають менший вплив на ефективність балансування ніж сили в'язкості.

Ключові слова: ротор, критична швидкість, дисбаланс, автоматичне балансування (самобалансування), ефективність балансування, автобалансируючий пристрій (АБП), в'язкість робочої рідини.

I.V. DRACH
Khmelnitsky National University

THE FLUID BALANCER STUDY: INFLUENCE OF THE VISCOSITY OF A LIQUID WORKING BODIES

The use of liquid auto-balancers to compensate for the operational changes in the imbalance of rotary systems without stopping them is of interest because of the relative structural simplicity of these devices, which are passive direct-acting regulators that do not require power supply and control systems to move correction masses. The experience of the study of passive auto-balancing devices (ABD) indicates that the existing theory (statements) of passive automatic balancing of the fluid is idealized and inaccurately describes the processes that occur with the working bodies during their operation. In particular, the lack of studies on the effect of liquid viscosity on the efficiency of self-balancing and the reasonableness of the selection of liquid during the construction of fluid ABD demanded to analyse the operation of liquid ABD in the real system, taking into account the influence of liquid properties on the efficiency of the vertical rotor balancing process. It is shown that the: automatic fluid balancing is effective for elastically de-formable rotors, on elastic supports ones, where there is a phase difference between the direction of force from the imbalance and the rotor deflection or the displacement of the rotor; automatic balancing with the help of liquid working bodies of different densities for the vertical rotor exists at the pre-resonance, after resonance (operating) frequencies and at resonance; the efficiency of balancing increases with the approach of the angular velocity to the critical one and with the increase of the phase angle, that is, with the increase of the external resistance; liquid density does not significantly influence the optimal filling of the ABD chamber on the process of self-balancing over the entire frequency range of the rotor; the viscosity significantly affects the vibration of the rotor, even with optimum filling. Consequently, for the liquid ABD, mass forces have less effect on the balancing efficiency than the viscosity; when the chamber is filled with more liquid than the optimal volume, there is a deterioration in the efficiency of the balancing, which can be explained by the presence of waves on the free surface of the liquid, which causes a dynamic instability in the work of the machine.

Keywords: Rotor, critical speed, imbalance, automatic balancing (self-balancing), balancing efficiency, auto balancing device (ABD), working fluid viscosity.

1916

(Leblanc)

[3].

(E.L. Thearle) [4].

E.L. Thearle

[5], [6], H.S. Hoon, L.J. Young, S. Suzuki [7], [8, 9], Chung-Hyo Jung, Chang-Sub Kim, Yun-Ho Choi [10], M.A. Langthjema, T. Nakamurab [11], Cunico M.W.M. [12], H.-W. Chen, W.-X. Ji, Q.-J. Zhang, Y. Cao and S.-Y. Fan [13]

Internet

LG Electronics Inc. [14, 15], Whirlpool Corporation [16], SKF AutoBalancer Systems [17], Samsung Electronics Co. Ltd [18].

ω ,
(

R h

$$\bar{D}_c = \bar{D} \cdot \frac{m}{m+M} \quad (1)$$

$$\bar{D}_0 = \bar{D} \cdot \frac{M}{m+M} \quad (2)$$

$$\bar{OC} = \bar{e} = \frac{\bar{D}}{m+M} \quad (3)$$

$$\bar{OC}_0 = \bar{e}_0 = \frac{\bar{D}_0}{m+M} \quad (4)$$

$$\bar{OC}_c = \bar{e}_c = \frac{\bar{D}_c}{M+m} \quad (5)$$

[1].

$\omega < \omega$

(I-I)

(OC) (1).

$$\bar{D}_c = (M+m) \cdot \bar{e}_c \quad \bar{D}_0 = M \cdot \bar{e}_0 \quad (6)$$

$$\bar{D} = m \cdot \bar{e} \quad (7)$$

\bar{D}_0 (

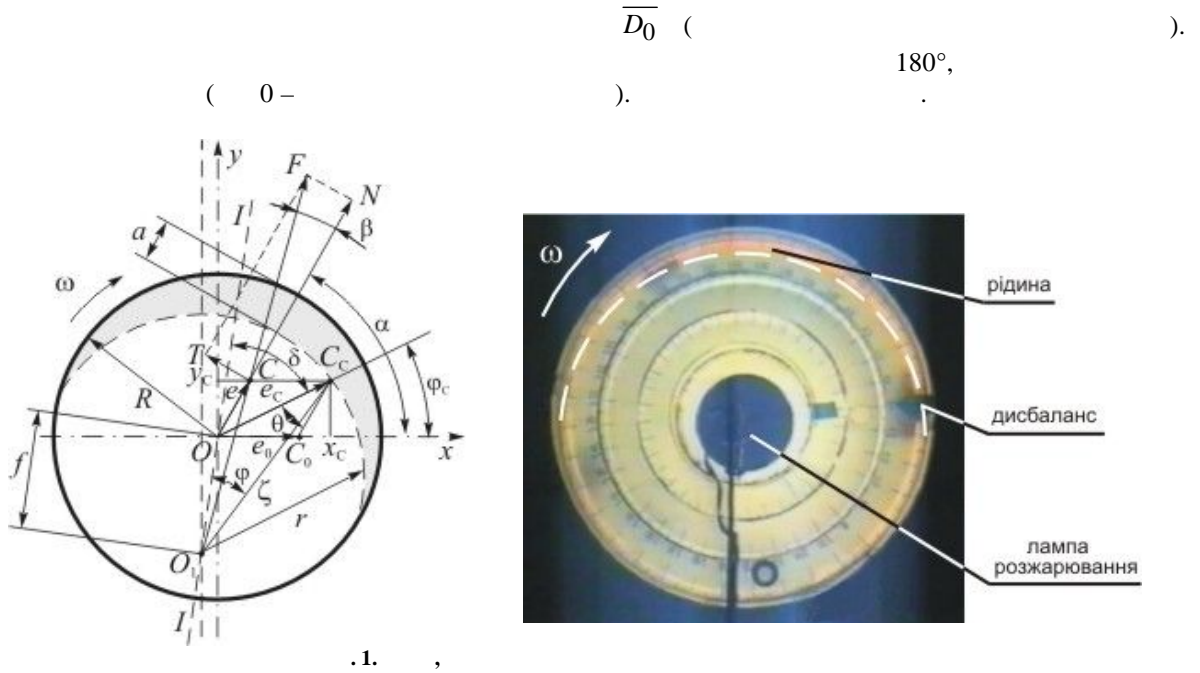

1.

$$e_c = \sqrt{x_c^2 + y_c^2} = e\sqrt{1 + 2k \cos \alpha + k^2}.$$

$$k = \frac{D_0}{D} -$$

$$\text{tg } \alpha = 0, \quad f[\text{tg } \alpha \cos(\delta + \varphi_c) - \sin(\delta + \varphi_c)] = 0.$$

(= 0):

$$f = 0; \quad \text{tg } \alpha_0 \cos(\delta + \varphi_{0c}) - \sin(\delta + \varphi_{0c}) = 0. \quad (1)$$

(1))

$$\text{tg } \alpha_0 = \text{tg}(\delta + \varphi_{0c}).$$

$$e, e/e_0, e_c, \quad \sin \alpha_0 = \frac{1}{k} \sin \delta \sqrt{1 + 2k \cos \alpha_0 + k^2}. \quad (2)$$

(2)

(= 0, k > 0)

(= 0),

(6) 0, k > 0

(= 0):

$$\alpha_0 = \pi - \arccos\left(\sin^2 \delta + \sqrt{(\sin^2 \delta - 1) \cdot (\sin^2 \delta - k^2)}\right) \quad (3)$$

(3),

$$\delta \in \left(0, \frac{\pi}{2}\right) \quad \alpha_0 \in \left(\frac{\pi}{2}, \pi\right);$$

0:

$$\lambda_0 = \frac{k}{\sqrt{1 + 2k \cos \alpha_0 + k^2}}; \quad (4)$$

$$1 + 2k \cos \alpha_0 + k^2 = 0$$

$$k = 1 \quad \cos \alpha_0 = -1,$$

(k > 1).

[19].

[20].

[20]

$$\Delta P = \frac{4F_T}{\pi d^2},$$

$d -$

$$F_T = \frac{\pi}{4} \Delta P \cdot d^2.$$

[19]

$$\Delta P = \rho \cdot g \cdot \lambda \frac{l}{d} \frac{v^2}{2g} = \rho \lambda \frac{l}{d} \frac{v^2}{2},$$

$l -$
 $v -$

($Re < Re$)

$$\lambda = \frac{64}{Re},$$

[20].

$$Re = \frac{vd}{\nu} = \frac{v\rho d}{\mu}$$

($-$, $\mu -$,) , $\lambda = \frac{64 \cdot \mu}{v\rho \cdot d}$. ,

$$\begin{aligned} F_T &= \frac{\pi}{4} d^2 \cdot \rho \lambda \frac{l}{d} \frac{v^2}{2} = \frac{\pi d^2 \rho \cdot 64 \mu \cdot l \cdot v^2}{8 d^2 \cdot v \rho} = 8 \pi \mu \cdot l \cdot v = 8 \pi \mu \cdot \frac{\pi R \xi}{180} \cdot \omega \cdot |\overline{O_1 C}| = \\ &= \frac{8 \pi^2 \mu \cdot R \xi \cdot \omega}{180} \sqrt{(e \cos \alpha + f \cos(\delta + \varphi_c))^2 + (e \sin \alpha + f \sin(\delta + \varphi_c))^2}, \end{aligned} \tag{5}$$

(7)

(F_T)

(T)

$$: F_T = T \quad , \quad T = F \cdot \sin \beta \quad , \quad \sin \beta = \frac{F_T}{F}$$

$$\sin \beta = \frac{8 \pi^2 \mu \cdot R \cdot \xi \cdot \omega |\overline{O_1 C}|}{180 \cdot m \cdot \omega^2 |\overline{O_1 C}|} = \frac{8 \pi^2 \mu \cdot R \cdot \xi}{180 \cdot m \cdot \omega} . \tag{6}$$

$$tg \beta = \frac{\sin \beta}{\pm \sqrt{1 - \sin^2 \beta}} .$$

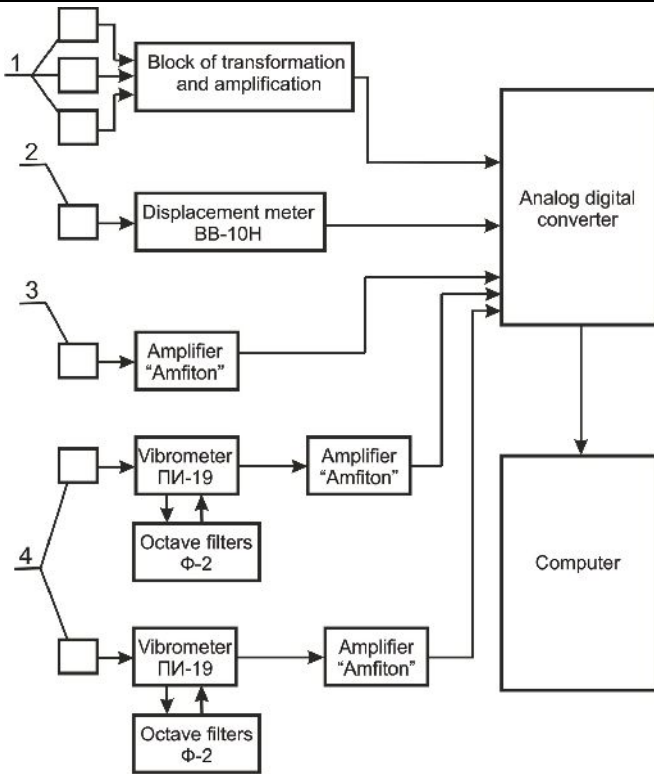

1 - ; 2 - ; 3 - ; 4 - ;

150

150-200

100 (D=2000)

[4]

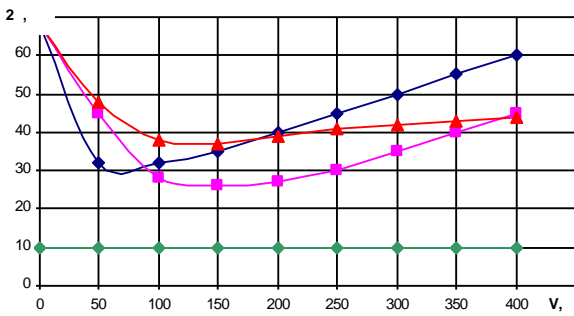

Legend for Graph 3: Blue diamond, Red triangle, Magenta square, Green circle

3.

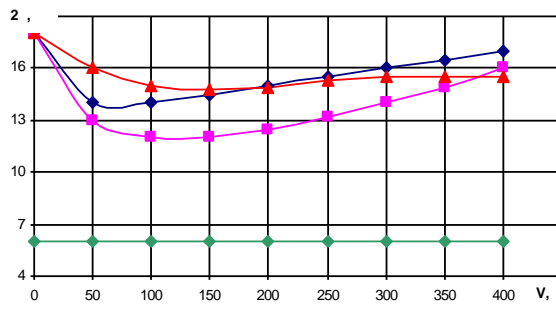

Legend for Graph 4: Blue diamond, Red triangle, Magenta square, Green circle

4

100

2000

40%

(6)

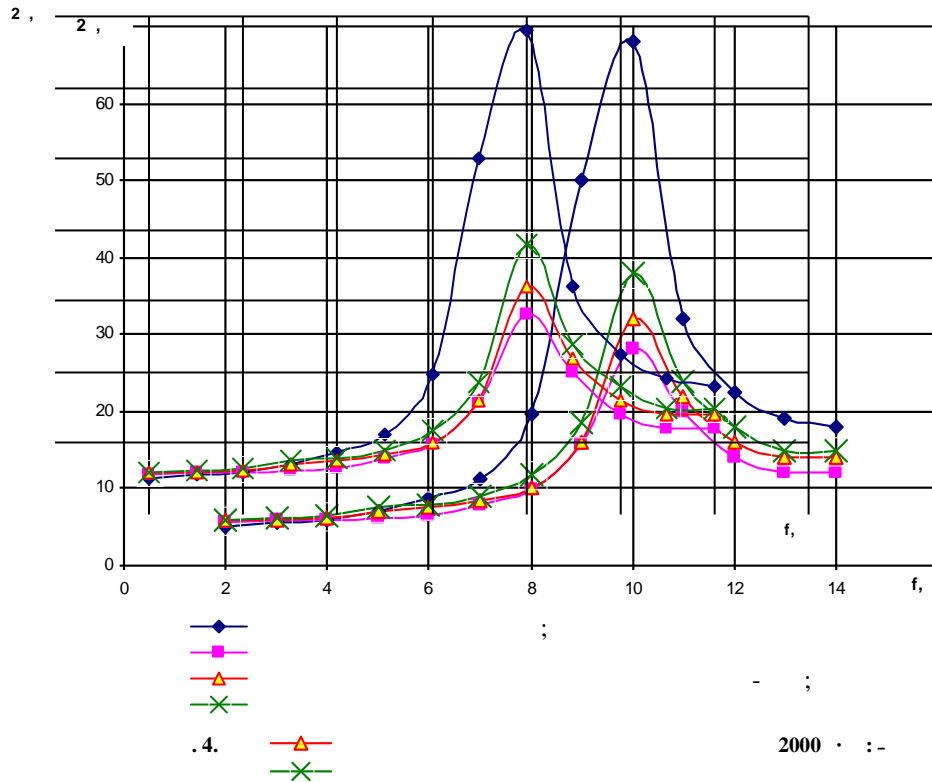

.4

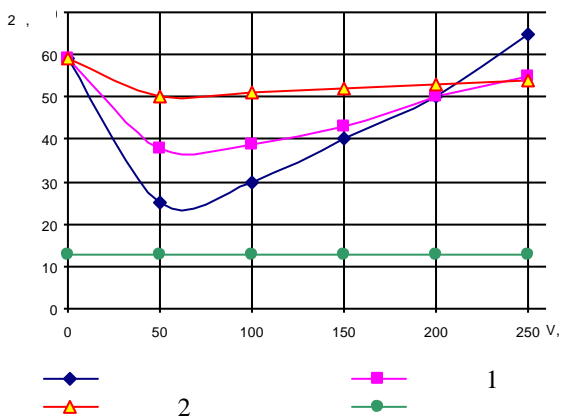

.5

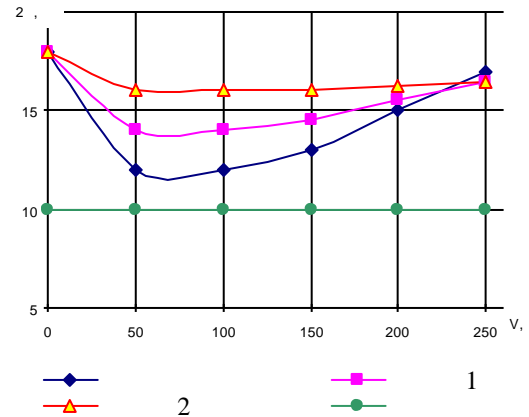

.5

$14,4 \cdot 10^{-6} \text{ } ^2/ -$
 $96,97 \cdot 10^{-6} \text{ } ^2/ -$
 (6275)
 ;)
 ($1000 / ^3$; $1,01 \cdot 10^{-6} \text{ } ^2/ -$
 $1 (1230 / ^3$; ,
 $2 (1370 / ^3$; ,
)
 ,
 $D=1000$.
 200 , 50
 $50-100$.

5. . . . : 2 . / – . : , 2004.
6. . . . : a : 05.02.18 “ ”/ – , 1990. – 34 .
7. Hoon H. S. A study on the dynamic behaviour of an automatic washing machine / H. S. Hoon, L.J. Young, S. Suzuki, H. W. Gu // *Nippon Kikai Gakkai Kankyo Kogaku Sogo Shinpojiumu Koen Ronbunshu*. – 2001. Vol. – 11. – P. 131–134.
8. Pashkov E. Efficiency of Balancing by Liquid-Type Automatic Balancing Devices / E.N. Pashkov, N.V. Martyushev, A.V. Ponomarev // *Advanced Materials Research : Scientific Journal*. – 2014. – Vol. – 1040 : High Technology: Research and Applications. – 2014 (HTRA 2014). – P. 858–863.
9. Pashkov E. Evaluation of Gravitational Force Effect on Balancing Processes in Liquid-Type Autobalancing Devices / E. N. Pashkov, N. V. Martyushev, I. A. Masson // *Advanced Materials Research : Scientific Journal*. – 2014. – Vol. 1040 : High Technology: Research and Applications 2014 (HTRA 2014). – P. 642–649.
10. Jung C.H. A dynamic model and numerical study on the liquid balancer used in an automatic washing machine / C.H. Jung, C.S. Kim, Y.H. Choi // *Journal of Mechanical Science and Technology*. – 2008. – Vol. – 22. P. 1843–1852.
11. Langthjem M. A. Dynamics of the fluid balancer: Perturbation solution of a forced Korteweg-de Vries-Burgers equation / M. A. Langthjem, T. Nakamura // *数理解析研究所講究録 第卷*– 2013. – Vol. – 1847. – P. 73–85.
12. Marlon Wesley Machado Cunico Characterization and Modelling of LeBlanc Hydrodynamic Stabilizer: A Novel Approach for Steady and Transient State Models / M. W. M. Cunico // *Modelling and Simulation in Engineering*. – 2015. – Vol. – 2015, Article ID 729582, 11 pages.
13. Chen H.-W. Study on steady-state response of a vertical axis automatic washing machine with a hydraulic balancer using a new approach and a method for getting a smaller deflection angle / H.-W. Chen, Q. Zhang, S.-Y. Fan // *J. Sound Vib.* – 2011. – Vol. 330. – P. 2017–2030.
14. Pat. US 9663889 B2 Republic of Korea. Laundry treating apparatus [] / Keunjoo Kim, Jinwoong Kim, Seungchul Park. – Owner name: Lg Electronics Inc. – . 19.02.2015 ; . 30.05.2017, US 14/626,420. – : <http://www.google.com/patents/US9663889> (may 30, 2017)
15. Pat. EP 3085827 A1 Republic of Korea. Balancing unit and laundry treatment apparatus [] / Keunjoo Kim, Jinwoong Kim, Seungchul Park. – Owner name: Lg Electronics Inc. – . 11.02.2014 ; . 26.05.2016, US EP20160165454. – : <http://www.google.com/patents/EP3085827A1?cl=en> (may 26, 2016)
16. Pat. US 20120144598 A1 Republic of Korea. Laundry treating appliance with balancing system [] / Stephen D. Ostdiek., Vishal Verma. – Owner name: Whirlpool Corporation – . 08.12.2010 ; . 14.06.2012, US EP20160165454. – : <http://www.google.com/patents/US20120144598> (June 14, 2012)
17. SKF-Automatic balancing units [] : Automatic balancing units. – : <http://www.skf.com/us/industry-solutions/portable-power-tools/applications/grinders-planners-and-sanders/automatic-balancing-unit/index.html> (December 01, 2017)
18. Pat. US 8984918 B2 Republic of Korea. Washing machine, inner tub of washing machine and balancer connection and assembly method thereof [] / Yong Kwon Kim, Kyu Chai Lee, Hong Seok Ko, Sang Up Lee. – Owner name: Samsung Electronics Co., Ltd. – . 20.08.2010 ; . 24.03.2015, US 12/805,861. – : www.google.com/ua/patents/US8984918 (March 24, 2015)
19. . . . : , 1993. – 431 .
20. . . . ()/ . . . , . . . – . : , 1975. – . 24–25.

References

1. Royzman V. Improving theory for automatic balancing of rotating rotors with liquid self balancers / V. Royzman, I. Drach // *Mechanika*. – 2005. – 4 (54). – P. 38–44.
2. Royzman V. System Analysis of Automatic Balancing (Self-Balancing) Machine Rotors with Liquid Working Bodies / V. Royzman, A. Bubulis, I. Drach // *Solid State Phenomena*. – 2009. – Vol. 147–149. – P. 374–379.
3. Nykyforov A.N. Sostoianye problemy uravnoveshyvaniya rotorov / A.N. Nykyforov // *Vestnyk nauchno-tekhnycheskoho razvytyia*. – 2013. – 4 (68). – C. 20–28.
4. Thearle E.L. Automatic dynamic balancers (Part 1. Leblanc balancer) / E.L. Thearle. – *Machine Design*, 1950. – P. 119–124.
5. Husarov A.A. Balansyrovka rotorov mashyn : 2 kn. / A.A. Husarov. – M. : Nauka, 2004.
6. Nesterenko V.P. Teoriya y praktyka ustroystv avtomaticheskoi balansyrovky rotorov : avtoref. dyss. ... d-ra tekhn. nauk : 05.02.18 “Teoriya mekhanyzmov y mashyn” / V.P. Nesterenko. – Novosybyrsk, 1990. – 34 s.
7. Hoon H. S. A study on the dynamic behaviour of an automatic washing machine / H. S. Hoon, L.J. Young, S. Suzuki, H. W. Gu // *Nippon Kikai Gakkai Kankyo Kogaku Sogo Shinpojiumu Koen Ronbunshu*. – 2001. Vol. – 11. – P. 131–134.
8. Pashkov E. Efficiency of Balancing by Liquid-Type Automatic Balancing Devices / E.N. Pashkov, N.V. Martyushev, A.V. Ponomarev // *Advanced Materials Research : Scientific Journal*. – 2014. – Vol. – 1040 : High Technology: Research and Applications. – 2014 (HTRA 2014). – P. 858–863.

9. Pashkov E. Evaluation of Gravitational Force Effect on Balancing Processes in Liquid-Type Autobalancing Devices / E. N. Pashkov, N. V. Martyushev, I. A. Masson // *Advanced Materials Research : Scientific Journal*. – 2014. – Vol. 1040 : High Technology: Research and Applications 2014 (HTRA 2014). – P. 642–649.
10. Jung C.H. A dynamic model and numerical study on the liquid balancer used in an automatic washing machine / C.H. Jung, C.S. Kim, Y.H. Choi // *Journal of Mechanical Science and Technology*. – 2008. – Vol. – 22. P. 1843–1852.
11. Langthjem M. A. Dynamics of the fluid balancer: Perturbation solution of a forced Korteweg-de Vries-Burgers equation / M. A. Langthjem, T. Nakamura // *数理解析研究所講究録 第卷* – 2013. – Vol. – 1847. P. – 73–85.
12. Marlon Wesley Machado Cunico Characterization and Modelling of LeBlanc Hydrodynamic Stabilizer: A Novel Approach for Steady and Transient State Models / M. W. M. Cunico // *Modelling and Simulation in Engineering*. – 2015. – Vol. – 2015, Article ID 729582, 11 pages.
13. Chen H.-W. Study on steady-state response of a vertical axis automatic washing machine with a hydraulic balancer using a new approach and a method for getting a smaller deflection angle / H.-W. Chen, Q. Zhang, S.-Y. Fan // *J. Sound Vib.* – 2011. – Vol. 330. – P. 2017–2030.
14. Pat. US 9663889 B2 Republic of Korea. Laundry treating apparatus [Elektronnyi resurs] / Keunjoo Kim, Jinwoong Kim, Seungchul Park. – Owner name: Lg Electronics Inc. – zaiavl. 19.02.2015 ; opubl. 30.05.2017, Biul. US 14/626,420. – Rezhym dostupu : <http://www.google.com/patents/US9663889> (may 30, 2017)
15. Pat. EP 3085827 A1 Republic of Korea. Balancing unit and laundry treatment apparatus [Elektronnyi resurs] / Keunjoo Kim, Jinwoong Kim, Seungchul Park. – Owner name: Lg Electronics Inc. – zaiavl. 11.02.2014 ; opubl. 26.05.2016, Biul. US EP20160165454. – Rezhym dostupu : <http://www.google.com/patents/EP3085827A1?cl=en> (may 26, 2016)
16. Pat. US 20120144598 A1 Republic of Korea. Laundry treating appliance with balancing system [Elektronnyi resurs] / Stephen D. Ostdiek., Vishal Verma. – Owner name: Whirlpool Corporation – zaiavl. 08.12.2010 ; opubl. 14.06.2012, Biul. US EP20160165454. – Rezhym dostupu : <http://www.google.com/patents/US20120144598> (June 14, 2012)
17. SKF-Automatic balancing units [Elektronnyi resurs] : Automatic balancing units. – Rezhym dostupu : <http://www.skf.com/us/industry-solutions/portable-power-tools/applications/grinders-planners-and-sanders/automatic-balancing-unit/index.html> (December 01, 2017)
18. Pat. US 8984918 B2 Republic of Korea. Washing machine, inner tub of washing machine and balancer connection and assembly method thereof [Elektronnyi resurs] / Yong Kwon Kim, Kyu Chai Lee, Hong Seok Ko, Sang Up Lee. – Owner name: Samsung Electronics Co., Ltd. – zaiavl. 20.08.2010 ; opubl. 24.03.2015, Biul. US 12/805,861. – Rezhym dostupu : www.google.com.ua/patents/US8984918 (March 24, 2015)
19. Dushchenko V.P. Zahalna fizyka: Fizychni osnovy mekhaniky: Molekuliarna fizyka i termodynamika. / V.P. Dushchenko, I.M. Kucheruk. – K. : Vyshcha shk., 1993. – 431 s.
20. Altshul A.D. Hydravlyka y aerodynamyka (Osnove mekhaniky zhydkosty) / A.D. Altshul, P.H. Kyselov. – M. : Stroiizdat, 1975. – S. 24–25.

/Peer review : 13.02.2018 .

/Printed :28.03.2018 .

: . . . ,